

EF1SRP-01US2 Supplement (M32C/83 Group Edition)

First Edition issued Mar. 2003

1. General Description

This supplement contains information required for reading, writing and clearing data to/from Mitsubishi Electric M32C/83 Group MCU with built-in flash memory. The supplement can be referred in case of using EF1SRP-01U in EFP-S2.

2. Operating Environment

Use the MCU mentions in this supplement in an environment as follows.

Table 2.1: Operating Environment List

MCU Group Name	EFP-S2 Monitor Version	WinEFP2 Version	EF1SRP-01US2.TBL Version
M32C/83 Group	Ver.1.00.00 or later	Ver.1.00.00 or later	Ver.1.00.00 or later
Each S/W version number can be referred to [Help] → [About] in WinEFP2 window menu. If your S/W version of EFP-S2 is old one, download the latest version data from the website below. <EFP-S2's latest S/W free download site > http://www.suisei.co.jp/verup/verup_e.htm			

3. Command Specifications of Each Distinction

This supplement contains special command description using for M32C/83 serial I/O mode, however command correspondence contents are different by each MCU group.

The command correspondence list is given in Table 3.1.

Table 3.1: Operating Environment List

MCU Group Name	ID Collation	Block Set	Block Erase	Boot Read
M32C/83 Group	○	○	○	○
+ ○ means "correspondence", and x means "not correspondence". Refer to following articles for description of command by each group; ID Collation: 5. ID Code Field / 6. ID Collation Function Block Set: 7. Block Set Command Block Erase: 8. Erase Command Boot Read: 9. Boot Read Command				

4. Pin Connection

Table 4.1 lists the connection of target connection cable pin of the M32C/83 Group.

Table 4.1: Connection of the Target Connection Cable Pin

Pin No. (EF1SRP-01U side)	Target End Wire Color	Signal	4-Wire Cable Pin No.	MCU Connection Pin For Serial Input/Output	Input/Output (writer side)
1	Orange/red dotted 1	GND	1	Connects to VSS pin *3	-
2	Orange/black dotted 1				
3	Gray/red dotted 1	T_VPP	4	Unconnected	Open
4	Gray/black dotted 1	T_VDD	5	Connects to VCC pin *1	Input
8	White/black dotted 1	T_PGM/OE /MD	8	Connects to CNVSS pin	Output
9	Yellow/red dotted 1	T_SCLK	6	Connects to SCLK pin	Output
10	Yellow/black dotted 1	T_TXD	7	Connects to RXD pin	Output
11	Pink/red dotted 1	T_RXD	2	Connects to TXD pin	Input
12	Pink/black dotted 1	T_BUSY	3	Connects to BUSY pin	Input
14	Orange/black dotted 2	T_RESET	9	Connects to RESET pin *2	Output
15	Gray/red dotted 2	GND	10	Connects to VSS pin *3	-
16	Gray/black dotted 2				

Supplement of Pin Treatment:

- 1) Supply VCC from user side to match source voltage of output buffer used on EFP-S2 side with user side source voltage (VCC).
- 2) Reset cancel is not carried out during using a writer. To execute user program, you should therefore unplug the target connection cable to the writer. As for RESET output at writer side, see Note 3 in the page 3.
- 3) The signal GND has 4 pins (No. 1, 2, 15 and 16) of EF1SRP-01US2 side connector. When connecting to the target board, you can connect with using only one pin, but connecting more than 2 pins is recommended.

Supplement for others:

- 4) During serial I/O mode, connect the \overline{CE} pin and the \overline{EPM} pin of the MCU to the VCC pin and the VSS pin respectively.
- 5) Connect the MCU's Xin and Xout terminals to the oscillator circuit.

(1) A recommended sample of user target MCU peripheral circuit for M32C/83 is shown in Fig.4.1.

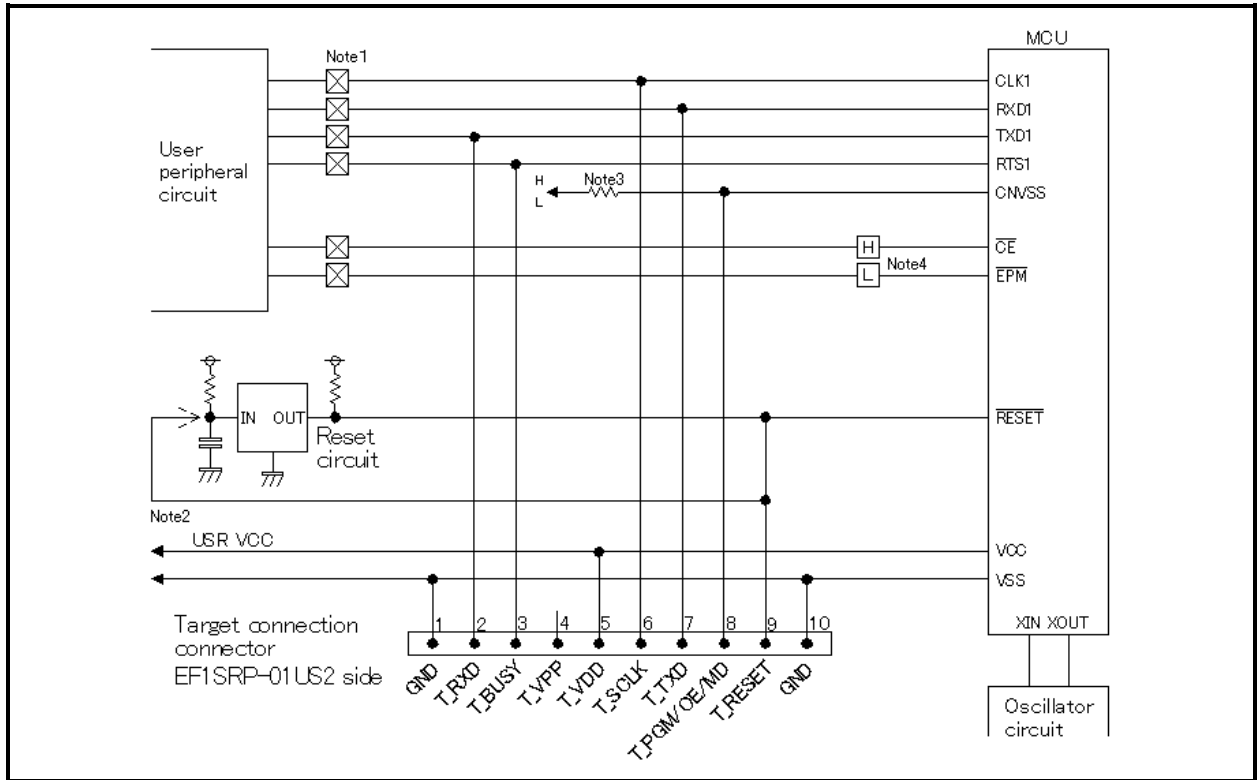

Fig.4.1: User Target Peripheral Circuit Example (recommended)

Notes:

- 1: If the user peripheral circuit is an output circuit, you should disconnect by jumper to avoid output collision when executing serial I/O mode. (see Fig. 4.2)
- 2: EFP-S2 side reset output is an open collector, therefore connect to the RESET pin with 1kΩ pull-up resistor for open collector output. If the reset circuit is CMOS output, disconnect by jumper as described in Notes 1, or connect the EFP-I side T_RESET signal to reset circuit input. Make reset delay within 30ms.
- 3: Pull-down the CNVSS pin by the resistor at 5.1kΩ before connecting.
- 4: When executing serial I/O mode, fix the CE and EPM to “H” and “L” respectively. In other case, connect to the user peripheral circuit or pull-up/pull-down.

(2) An example of a collision prevention circuit when user peripheral circuit outputs is shown in Fig. 4.2 and 4.3.

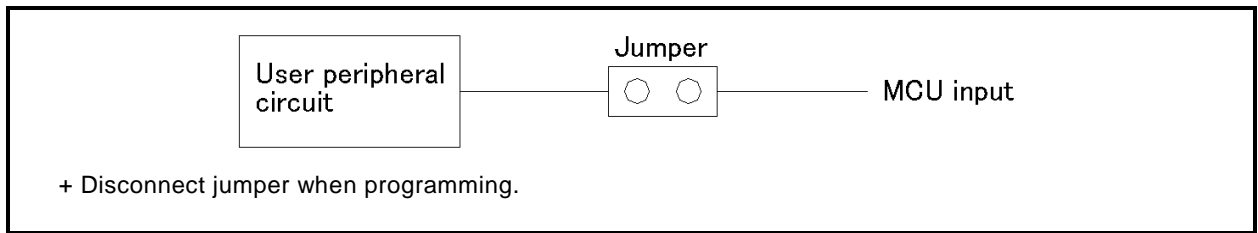

Fig.4.2: Collision Prevention Circuit Using Jumper

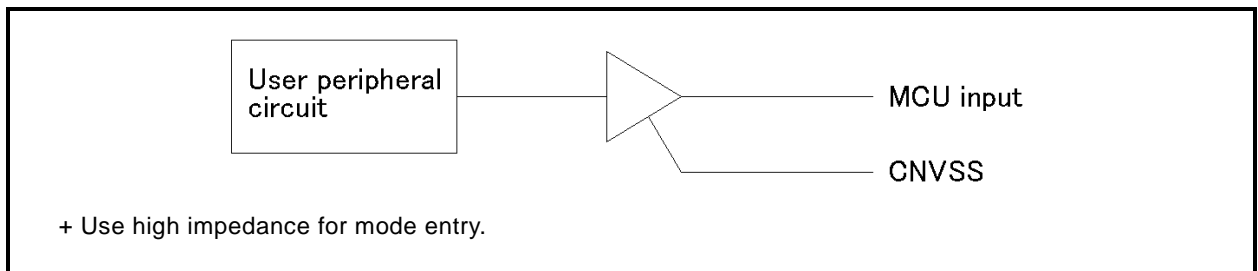

Fig. 4.3: Collision Prevention Circuit Using Three State Buffer

5. ID Code Field

ID code field is provided in the internal flash memory of M32C/83 Group MCUs. Fulfilling the following condition enables you to prohibit writing and reading of MCU's internal flash memory.

Condition for working ID Code Protect Function:

Condition 1: Writes data except FFh to FFFFFFFh of the flash memory.

Condition 2: Writes ID code of your choice in ID code field.

Condition 3: Fulfills condition 1 and 2, and then turn on MCU again.

MCU protected by writing ID code, can be released protected status by ID collation function of WinEFP2.

For the ID collation function, see "6. ID Collation".

This function is for preventing of incorrect data loading etc. of user's program.

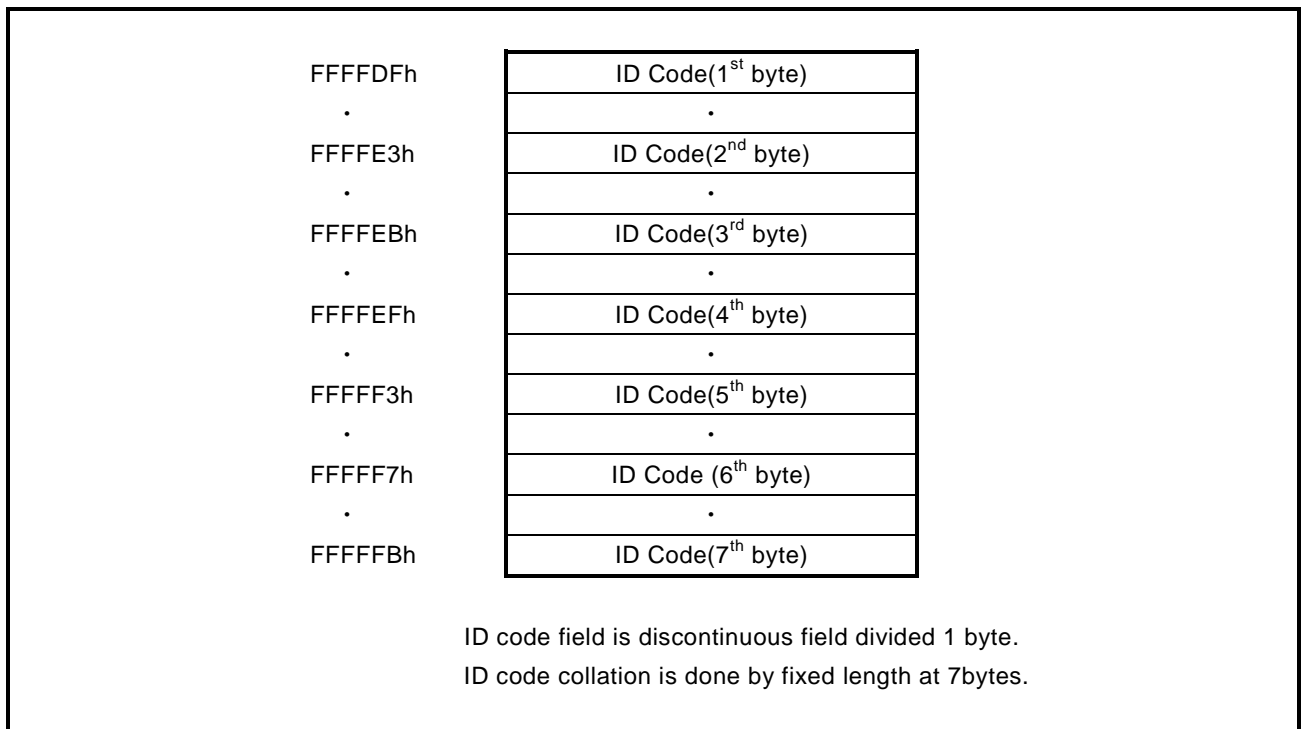

Fig. 5.1: ID Code Field Configuration

6. ID Collation Function

ID collation command enables you to reset protected MCU after written ID code.

The command is executed by inputting the ID input format and ID code for the ID collation parameter of the WinEFP2 environment setting dialog.

When ID code match after executing ID collation command, protect status is reset. However, all commands of [Device] of the WinEFP2 window menu cannot be used if the ID code does not match.

The ID collation parameter layout is shown in Fig. 6.1.



The image shows a dialog box titled "ID Collation". It has three main sections. The first section is "Input Format(I):" with two radio buttons: "ASCII" (which is selected) and "HEX". The second section is "Start Address(A):" with a text input field containing the hexadecimal value "FFFFDF". The third section is "ID Code(C):" with an empty text input field.

Fig. 6.1: ID Collation Parameter Layout

1) Input format

The ID code input format is specified as ASCII or HEX.

2) Start address

Specifies the start address of ID code field.

For this parameter, the ID code start address of MCU is set automatically.

3) ID code

Inputs the ID code fixed at 7 bytes.

6.1 ID Collation Operating Procedure

When you use an MCU which ID code field is provided, pay attention to the miswriting into the ID code field. To avoid slipping of ID code written in, keep the ID code at user's side. This article contains a description of the usage example and operation procedure of ID code. Consecutive procedure from ID code writing to ID code resetting is as follows.

Procedure 1: ID Code Setting

Sets ID code to the appropriate field for ID code field of EFP-S2's internal buffer. In the example below, ID code is set as "SUISEI". (see the Fig. 6.2.)

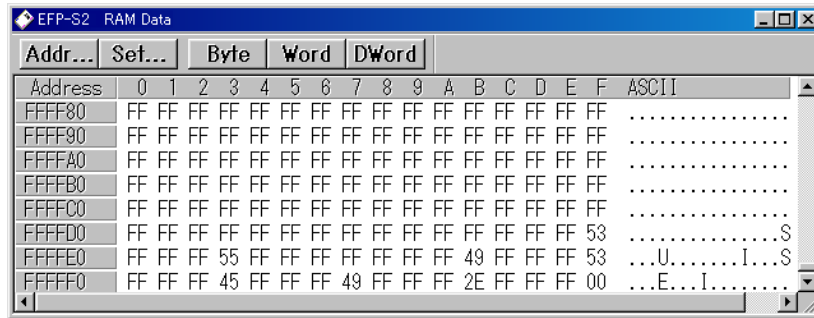

Fig. 6.2: Dump Window (ID Code Setting Data)

Fig. 6.1: Buffer RAM Setting Data List

Flash Memory Address	Setting Data	Flash Memory Address	Setting Data
FFFFDFh	53h	FFFFF3h	45h
FFFFE3h	55h	FFFFF7h	49h
FFFFEBh	49h	FFFFFBh	2Eh
FFFFEFh	53h	FFFFFn	00h

Procedure 2: Writing in the ID Code Field

Writes EFP-S2's internal buffer RAM data into the MCU internal flash memory. The Fig.6.3 shows an example for writing in the field included ID code field with using program command. After completion of writing into the ID code field, turn MCU's power on again.

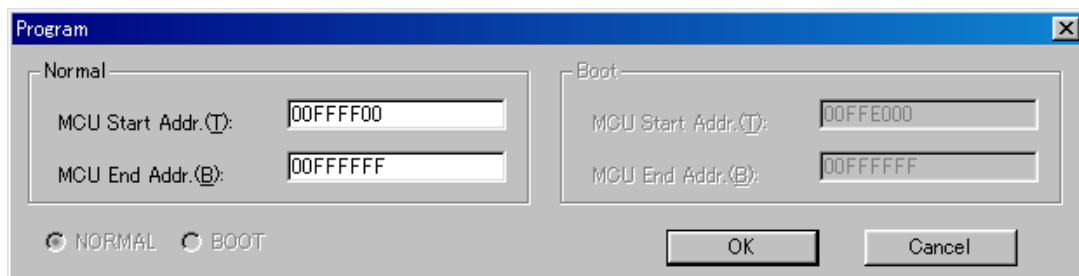

Fig. 6.3: Writing in the ID Code Field

Program Command Setting Address

Start address: FFFF00h
End address: FFFFFFh

Procedure 3: Checking Protected Status and Resetting

When executing the each command in [Device] of WinEFP2 window menu to the MCU written in the ID code, the error message dialog shown in Fig.6.4 is appeared and stop executing a command.



Fig.6.4: ID Error

Executes to collate ID code with using the ID collation command, and resets protected status at MCU's side. ID code inputting by each input format is shown in Fig.6.5 and 6.6.



Fig. 6.5: ID Collation (Input Format: ASCII)

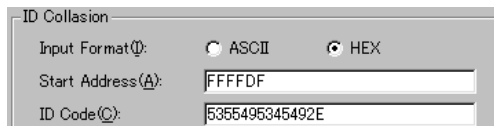

Fig. 6.6: ID Collation (Input Format: HEX)

If the ID code matches, protected status of MCU is reset and writing and reading to/from MCU are enabled. If error occurs after executing ID collation command, check ID code again and execute ID collation command.

7. Block Set Command

In the M32C/83 group MCU, internal flash memory is divided into several blocks, and every block has block-renewal-prohibition bit called lock bit.

The block set command handles for viewing and setting lock bit.

Setting a block's lock bit to "lock" allows you to protect the block from being written to or erased.

7.1 Screen Layout

Fig. 7.1 shows the screen layout of the block set command.

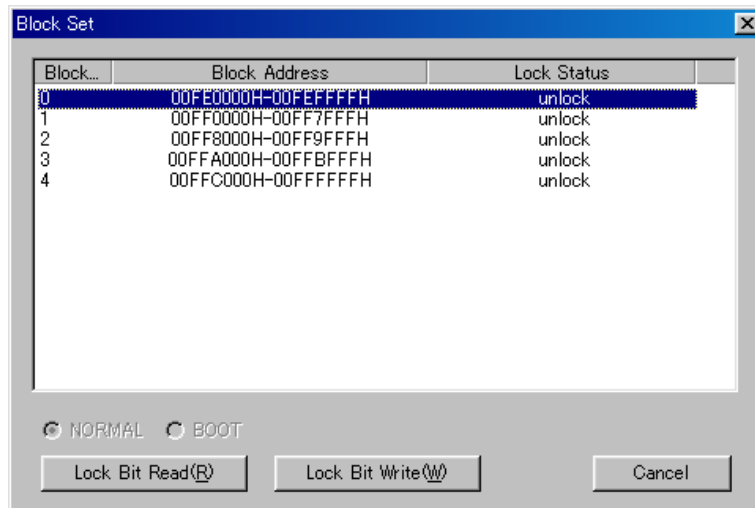

Fig. 7.1: Screen Layout of Block Set Command

1) Block No.

Indicates the block No. assigned to each block.

2) Block Address

Indicates the start address and the end address of each block.

3) Lock Status

Indicates the lock bit status for each block.

lock: The lock bit is locked.

Unlock: The lock bit is unlocked.

4) Radio button for selecting field

Selects a field to be erased.

5) Lock Bit Read Button

Reads all lock bit data from target MCU, and indicates lock bit status according to data contents.

6) Lock Bit Write Button

Setting a lock bit. The lock bit of the block, which is displayed "lock" in lock bit status, is set to "locked".

7) Cancel Button

Cancels command.

For setting a lock bit, see "7.2. Lock Bit Setting".

7.2 Lock Bit Setting

Followings are the steps to set a lock bit to "Lock".

This section contains a procedure to set unlocked lock bit to be locked.

To change a locked bit back to unlocked, see "8. Erase Command".

Procedure-1: Lock Type Setting

Lock type parameter specifies whether lock bit is to be effective or not.

Lock type parameter is located in Use Devise of WinEFP2 Environment Setting dialog.

Without setting lock type parameter, protect function by lock bit is not worked correctly.



Fig. 7.2. Lock Type Parameter

Lock type setting contents

Lock bit effective: Lock bit is effective

Procedure-2: Lock Bit Setting

Execute block set command. Then block set command dialog will be appeared.

Position the mouse cursor on the desired line and double-click to switch lock bit status in Lock Status, and set to lock side.

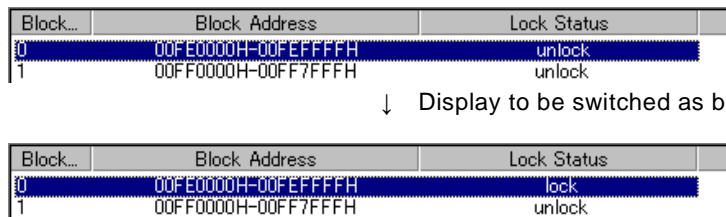

Block...	Block Address	Lock Status
0	00FE0000H-00FEFFFFH	unlock
1	00FF0000H-00FF7FFFH	unlock

↓ Display to be switched as below when double-clicking

Block...	Block Address	Lock Status
0	00FE0000H-00FEFFFFH	lock
1	00FF0000H-00FF7FFFH	unlock

Fig.7.3: Setting Lock Bit

Click the Lock Bit Write button, and execute block set command.

If you write or erase the protected block by lock bit after setting above, error occur and it stops to execute a command. Error doesn't occur by All Erase (all block to be erased together) command, but unlocked block is all erased.

8. Erase Command

The erase type parameter contained in the erase command enables you to erase by block or erase all blocks. The erase command parameter input dialog is shown in Fig. 8.1.

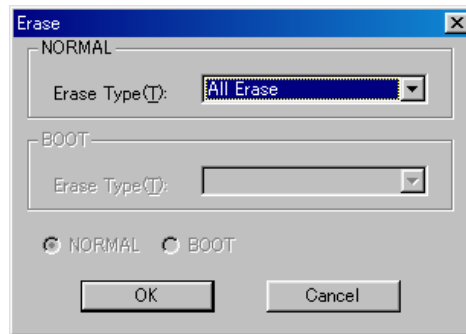

Fig. 8.1: Erase Command Parameter Input Dialog

1) Erase Type

All Erase and block address field (xxxxxxH – xxxxxxH) are displayed in the drop-down list to the right of the erase type parameter display field (displayed by clicking the arrow pointing downward with the mouse). Select the block erase method.

2) Radio button for selecting field

Select a field to be erased.

3) OK Button

Executes the block erase command.

4) Cancel Button

Cancels a command.

8.1 Lock Bit Releasing

Procedure for releasing a protected block by lock bit is as follows.

Procedure-1: Lock Bit Setting

Lock type parameter specifies whether lock bit is to be effective or not.

Lock type parameter is located in Use Device of WinEFP2 Environment Setting dialog.

Without setting lock type parameter, protect function by lock bit is not worked correctly.

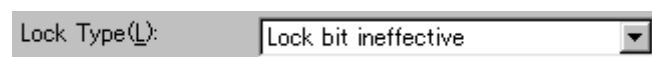

Fig. 8.2: Lock Type Parameter

Lock type setting contents

Lock bit ineffective: Lock bit is ineffective

Procedure-2: Lock Bit Erasing

Execute erase command. Then, Erase Command Parameter Input dialog is appeared.

Specify a protected block by lock bit or "All Erase" in Erase type parameter, and then execute Erase command.

9. Boot Read

Reads the data of the MCU's boot field, and then writes in the EFP-S2's internal buffer RAM.

Input a boot field address for the start and end address to execute the boot read command. Unfixed data will be read if address outside boot field is specified and execute the command.

The boot field address in each group is given in Table 9.1.

Table 9.1: Boot Field Address List

MCU Group Name	Boot Field Address
M32C/83 Group	FE000h ~ FFFFFh

10. Parameter Input by Device Command

When writing and reading are executed by device command, input command executing field by the page.

If wrong field is specified, a parameter error occurs and it stops to execute a command.

Page Input

Because one page of data is 256 bytes, input the start address and end address to xxxx00h and xxxxFFh when executing command.

11. Limitation on HEX File

Intel HEX and extension HEX format file are compatible with EFP-S2, but address field can be composed using HEX file is within 1Mega bite (from 0h to FFFFFh). If the address configuration of user program is more than 100000h, create HEX file with Motorola S format and download it to EFP-S2.

Table 11.1: HEX File Address Configuration

EFP-S2 compatible HEX File	Address Configuration
Intel HEX	00000000h ~ 0000FFFFh
Intel extension HEX	00000000h ~ 000FFFFFFh
Motorola S Format HEX	00000000h ~ FFFFFFFFh

In addition to above HEX file format, HEX file for Mitsubishi exclusive use is available. Mitsubishi exclusive HEX file enable to create address field from 0h to FFFFFFFh with Intel HEX format. It is impossible to download Mitsubishi HEX file to EFP-S2 directly, so exchange that file to Motorola S format HEX with using HEXTOS2.EXE enclosed Mitsubishi C compiler tool, and then download it to EFP-S2.